



Zastosowanie

Wentylacja wywiewna magazynów, hal sklepowych i przemysłowych, budynków gospodarczych w rolnictwie, etc. Ze względu na wysoką odporność temperaturową zalecane zwłaszcza jako odciąg z nad rusztów, z okapów w przemyśle mięsny oraz gastronomii. Do odciągów pary wodnej i mgły z zanieczyszczeniami tłuszczowymi szczególnie polecane wentylatory z wyrzutem pionowym.

Konstrukcja

Wentylator dachowy przeznaczony do pracy ciągłej w wysokich temperaturach.

- CTVB/4-180 | CTVB/4-225 od -40° do max. 200°C
- CTHB/4-180 | CTHB/4-225 od -40° do max. 200°C
- pozostałe od -40° do +120°C

Wirnik z blachy galwanizowanej (140-400) lub z blachy stalowej malowanej (450-630) wyważany dynamicznie. Obudowa z blachy aluminiowej, podstawa z blachy stalowej galwanizowanej. Wentylatory (typ 140-400) są przystosowane do regulacji prędkości obrotowej.

Silnik elektryczny

Asynchroniczny, trójfazowy 380-420V, 50Hz lub 220-240V, 50Hz silnik jednofazowy z kondensatorem. Silniki są wykonane zgodnie ze standardem IEC 72 i IEC 34-1. Klasa izolacji F, stopień ochrony IP 55.

Schemat podłączenia elektrycznego: rys. 9, 9a, 10 str. 583.



Wentylatory do wentylacji przeciwpożarowej

Oznaczenia





































CT V B / 4 - 140

- Średnica wirnika
- Ilość biegunów (prędkość obrotowa):
 - 4 ~1400 [obr./min]
 - 6 ~950 [obr./min]
 - 8 ~700 [obr./min]
- B silnik jednofazowy
- T silnik trójfazowy
- V wylot pionowy
- H wylot poziomy

Akcesoria































								
Podstawa dachowa RS str. 184	Podstawa tłumiąca RSA str. 184	Podstawa dachowa RSS str. 184	Kłapa zwrotna JCA str. 183	Złącze JPA str. 183	Króciec JBR str. 183	Złącze p-drg. JAE str. 183	Reb 4 - Auto str. 561	Reb 5 - Auto str. 561
								
regulator REB str. 560	regulator RMB, RMT str. 560	higrostat HIG-2 str. 562	czujnik SQA str. 562	termostat TS-2 str. 562	termostat TK-1 str. 562			

Dane techniczne wentylatorów CTHB/CTHT (wylot poziomy)

Typ	prędkość obrotowa [obr./min]	pobór mocy max. [W]	natężenie [A]	wydajność max. [m³/h]	poziom ciśnienia akustycznego przy 2/3 Q _{max} *		masa [kg]	nr artykułu
					wlot [dB(A)]	wylot [dB(A)]		
JEDNOFAZOWE 230V								
SILNIKI CZTEROBIEGUNOWE JEDNOFAZOWE								
CTHB/4-140	1370	60	0,32	800	46	52	7,5	43524010
CTHB/4-180	1330	50	0,33	990	46	52	8	43524020
CTHB/4-200	1320	120	0,6	1450	49	55	14,2	43524030
CTHB/4-225 	1350	170	0,9	2100	53	59	17	43524040
CTHB/4-250 	1320	280	1,4	3100	57	62	28	43524050
CTHB/4-315 	1375	590	2,7	4900	60	66	32	43524060
CTHB/4-400 	1380	1100	5,3	7000	67	73	42,5	43524070
SILNIKI SZEŚCIOBIEGUNOWE JEDNOFAZOWE								
CTHB/6-200 	940	80	0,4	970	38	45	14,2	43524110
CTHB/6-225 	890	90	0,4	1400	42	48	17	43524120
CTHB/6-250 	940	100	0,57	2000	45	52	28	43524130
CTHB/6-315 	840	170	0,81	3200	49	55	32	43524140
CTHB/6-400 	950	350	1,6	4500	56	62	42,5	43524150
TRÓJFAZOWE 400V								
SILNIKI CZTEROBIEGUNOWE TRÓJFAZOWE								
CTHT/4-140	1375	60	0,17	800	46	52	7,5	43524210
CTHT/4-180	1330	70	0,17	990	46	52	8	43524220
CTHT/4-200	1330	130	0,35	1450	49	55	14,2	43524230
CTHT/4-225 	1360	170	0,5	2100	53	59	17	43524240
CTHT/4-250 	1400	300	0,8	3100	57	62	28	43524250
CTHT/4-315 	1410	620	1,5	4900	60	66	32	43524260
CTHT/4-400 	1350	920	1,8	7000	67	73	42,5	43524270
CTHT/4-450 	1440	2000	4,6	10200	71	76	67	43524280
SILNIKI SZEŚCIOBIEGUNOWE TRÓJFAZOWE								
CTHT/6-200 	940	80	0,24	970	38	45	14,2	43524310
CTHT/6-225 	900	90	0,23	1400	42	48	17	43524320
CTHT/6-250 	950	100	0,41	2000	45	52	28	43524330
CTHT/6-315 	900	180	0,5	3200	49	55	32	43524340
CTHT/6-400 	925	350	1,0	4500	56	62	42,5	43524350
CTHT/6-450 	940	850	3,5	6900	59	66	67	43254360
CTHT/6-500 	965	1400	4,3	10500	63	69	104	43524370
CTHT/6-560 	950	2400	5,3	16000	66	73	118	43524380
CTHT/6-630 	950	3700	8,3	21000	70	76	156	43524390
CTHT/6-710 	980	6800	13,8	28900	77	83	217	43524400
SILNIKI OŚMIOBIEGUNOWE TRÓJFAZOWE								
CTHT/8-450 	700	700	2,1	5000	55	61	67	43524510
CTHT/8-500 	725	770	2,4	7500	55	62	104	43524520
CTHT/8-560 	730	1100	3,6	11500	58	65	118	43524530
CTHT/8-630 	735	1650	4,9	15000	62	69	156	43524540
CTHT/8-710 	730	2900	7,2	21700	70	76	226	43524550
SILNIKI DWUBIEGUNOWE TRÓJFAZOWE								
CTHT/4/8-315 	1400/700	370/230	1,10/0,90	4900/2400	60/45	66/51	33	43524265
CTHT/4/8-400 	1400/700	560/260	1,30/1,10	7000/3500	67/52	73/58	44	43524275
CTHT/4/8-450 	1400/700	2400/600	6,10/2,50	10200/5100	71/55	76/61	69	43524285
CTHT/6/12-450 	950/490	500/190	2,00/1,00	6900/3400	59/44	66/51	72	43524365
CTHT/6/12-500 	980/490	1520/430	4,50/2,20	10500/5300	63/48	69/54	109	43524375
CTHT/6/12-630 	960/480	4100/730	8,10/2,60	21000/10500	70/55	76/61	161	43524395
CTHT/9/12-710 	950/450	6700/850	14,1/5,4	28900/15000	77/62	83/68	226	43524405

* Wartość poziomu ciśnienia akustycznego mierzona na wylocie wentylatora przy wydajności maksymalnej (Q_{max}) i 2/3 wydajności maksymalnej (2/3 Q_{max}).

Dane techniczne wentylatorów CTVB/CTVT (wylot pionowy)

Typ	prędkość obrotowa [obr./min]	pobór mocy max. [W]	natężenie [A]	wydajność max. [m³/h]	poziom ciśnienia akustycznego przy 2/3 Q _{max} *		masa [kg]	nr artykułu
					włot [dB(A)]	wylot [dB(A)]		
JEDNOFAZOWE 230V								
SILNIKI CZTEROBIEGUNOWE JEDNOFAZOWE								
CTVB/4-140	1375	60	0,3	750	46	49	10	43524610
CTVB/4-180	1330	60	0,3	900	46	49	10,5	43524620
CTVB/4-200	1330	100	0,6	1350	49	53	17	43524630
CTVB/4-225 	1350	130	0,71	2000	53	56	19,8	43524640
CTVB/4-250 	1325	250	1,2	2950	56	60	35	43524650
CTVB/4-315 	1390	570	2,7	4700	60	64	39	43524660
CTVB/4-400 	1390	1100	5,3	6800	67	70	50	43524670
SILNIKI SZEŚCIOBIEGUNOWE JEDNOFAZOWE								
CTVB/6-200	940	80	0,4	900	38	42	17	43524710
CTVB/6-225 	890	90	0,4	1300	41	45	19,8	43524720
CTVB/6-250 	940	100	0,57	1850	45	49	35	43524730
CTVB/6-315 	870	160	0,8	3000	48	53	39	43524740
CTVB/6-400 	960	340	1,6	4300	55	59	50	43524750
TRÓJFAZOWE 400V								
SILNIKI CZTEROBIEGUNOWE TRÓJFAZOWE								
CTVT/4-140	1400	60	0,18	750	46	49	10	43524810
CTVT/4-180	1350	60	0,18	900	46	49	10,5	43524820
CTVT/4-200	1340	130	0,44	1350	49	53	17	43524830
CTVT/4-225 	1360	180	0,47	2000	53	56	19,8	43524840
CTVT/4-250 	1400	300	0,8	2950	56	60	35	43524850
CTVT/4-315 	1410	400	1,4	4700	60	64	39	43524860
CTVT/4-400 	1330	1000	1,8	6800	67	70	50	43524870
CTVT/4-450 	1440	2100	4,3	8990	70	74	75	43524880
SILNIKI SZEŚCIOBIEGUNOWE TRÓJFAZOWE								
CTVT/6-200	950	80	0,24	900	38	42	17	43524910
CTVT/6-225 	900	90	0,23	1300	41	45	19,8	43524920
CTVT/6-250 	950	100	0,41	1850	45	49	35	43524930
CTVT/6-315 	910	160	0,44	3000	48	53	39	43524940
CTVT/6-400 	930	350	1	4300	55	59	50	43524950
CTVT/6-450 	950	800	3,5	6300	59	63	75	43254960
CTVT/6-500 	975	1500	3,7	10000	62	66	115	43524970
CTVT/6-560 	950	2400	5,5	15000	66	70	129	43524980
CTVT/6-630 	950	3900	8,3	19500	70	74	168	43524990
SILNIKI OŚMIOBIEGUNOWE TRÓJFAZOWE								
CTVT/8-450 	690	700	1,5	4800	55	59	75	43525010
CTVT/8-500 	700	770	2,4	7100	54	58	115	43525020
CTVT/8-560 	730	1100	3,3	10000	58	62	129	43525030
CTVT/8-630 	735	1650	4,9	13500	61	66	168	43525040
SILNIKI DWUBIEGUNOWE TRÓJFAZOWE								
CTVT/4/8-315 	1400/700	370/320	1,10/0,90	4700/2100	60/45	64/49	40	43524865
CTVT/4/8-400 	1400/700	560/260	1,30/1,10	6800/3300	67/52	70/55	52	43524875
CTVT/4/8-450 	1400/700	2400/600	6,10/2,50	10000/4500	70/55	74/59	77	43524885
CTVT/6/12-450 	960/490	500/190	2,00/1,00	6300/2800	59/44	63/48	80	43524965
CTVT/6/12-500 	980/490	1520/340	4,50/2,20	10000/4800	62/47	66/51	134	43524975
CTVT/6/12-630 	960/480	4100/730	8,10/2,60	19500/9500	70/54	74/59	173	43524995

* Wartość poziomu ciśnienia akustycznego mierzona na wylocie wentylatora przy wydajności maksymalnej (Q_{max}) i 2/3 wydajności maksymalnej (2/3 Q_{max}).

Wymiary [mm]

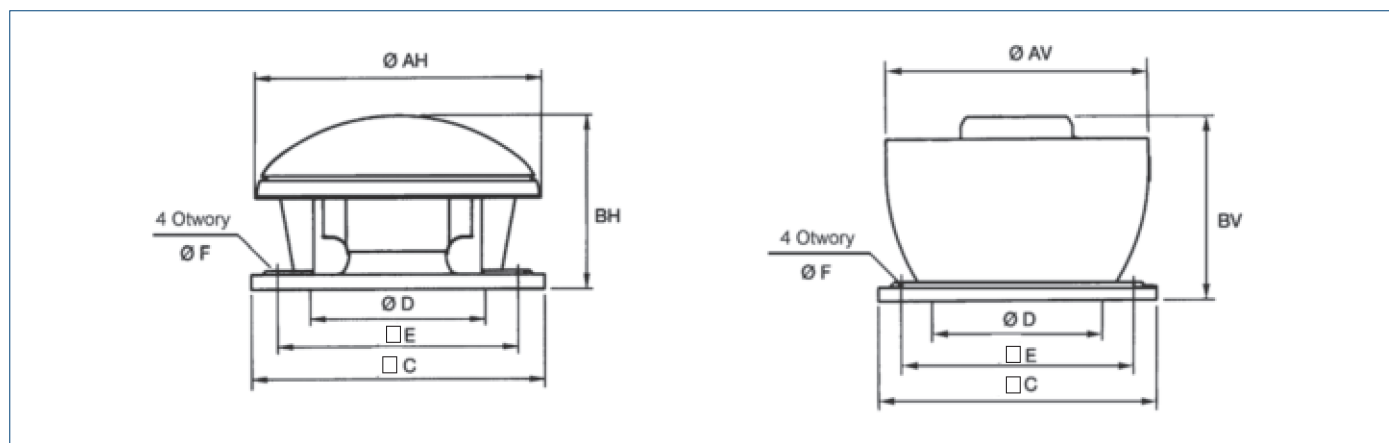

Typ	ØAH	ØAV	BH	BV	□C	ØD*	□E	ØF
140	415	421	277	359	300	180	245	10
180	415	421	292	374	300	180	245	10
200	561	556	340	404	435	250	330	12
225	561	556	383	452	435	250	330	12
250	762	750	425	522	560	355	450	12
315	762	750	469	564	560	355	450	12
400	850	850	532	608	630	400	535	12
450	962	950	713	741	710	500	590	14
500	1214	1216	824	832	905	630	750	14
560	1214	1216	874	832	905	630	750	14
630	1336	1327	1029	1053	1100	710	840	14

* - Nominalna średnica sugerowanego przewodu wentylacyjnego

Charakterystyka akustyczna

Widmo akustyczne oblicza się odejmując współczynniki korekcyjne przedstawione w poniższych tabelach od wartości z tabeli z danymi technicznymi.

Typ		częstotliwość w HZ						
		125	250	500	1000	2000	4000	8000
NA WYLOCIE	Q _{max}	2	7,5	11	11	9	6	0,5
	2/3 Q _{max}	-0,5	3,5	5,5	5,5	3,5	0,5	-4,5
	1/3 Q _{max}	-2,5	1,5	3,5	3,5	1,5	-1,5	-6,5
NA WLOCIE	Q _{max}	5,5	9	11,5	11	10	7,5	3,5
	2/3 Q _{max}	2,5	5	6	4,5	1,5	-2,5	-8,6
	1/3 Q _{max}	0,5	3	4	2,5	-0,5	-4,5	-10,5

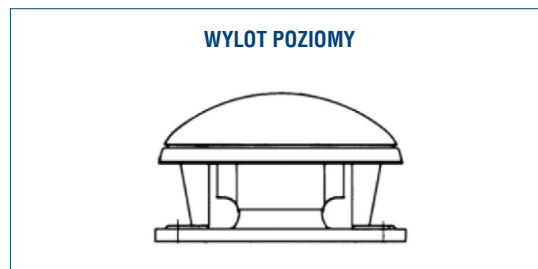

Typ		częstotliwość w HZ						
		125	250	500	1000	2000	4000	8000
NA WYLOCIE	Q _{max}	3	8	11,5	11,5	8	1,5	-8,0
	2/3 Q _{max}	0,5	4,5	6,5	5	1,5	-3,0	-10,0
	1/3 Q _{max}	-1,5	2,5	4,5	3	-0,5	-5,0	-12,0
NA WLOCIE	Q _{max}	4,5	9	10,5	8,5	6,5	5,5	3
	2/3 Q _{max}	3	5	6	4,5	1	-3,0	-9,5
	1/3 Q _{max}	1	3	4	2,5	-1,0	-5,0	-11,5



Widmo akustyczne

Ciśnienie akustyczne w odległości "d" obliczyć odejmując od każdego pasma częstotliwości widma akustycznego wartość korekty z poniższej tabeli.

ODLEGŁOŚĆ [d]	1 m	1,5 m	4 m	6 m	10 m	15 m	20 m	30 m
KOREKTA [dB]	11	14,5	23	26	31	34	37	40

Montaż

Typ	podstawa dachowa 1	podstawa tłumiąca 2	złącze JPA 3	klapa zwrotna 4	króciec JBR 5	złącze JAE 6
140	JBS-300	JAA-300	JPA-300	JCA-300	JBR-300	JAE-300
180	JBS-300	JAA-300	JPA-300	JCA-300	JBR-300	JAE-300
200	JBS-435	JAA-435	JPA-435	JCA-435	JBR-435	JAE-435
225	JBS-435	JAA-435	JPA-435	JCA-435	JBR-435	JAE-435
250	JBS-560	JAA-560	JPA-560	JCA-560	JBR-560	JAE-560
315	JBS-560	JAA-560	JPA-560	JCA-560	JBR-560	JAE-560
400	JBS-630	JAA-630	JPA-630	JCA-630	JBR-630	JAE-630
450	JBS-710	JAA-710	JPA-710	JCA-710	JBR-710	JAE-710
500	JBS-905	JAA-905	JPA-905	JCA-905	JBR-905	JAE-905
560	JBS-905	JAA-905	JPA-905	JCA-905	JBR-905	JAE-905
630	JBS-1100	JAA-1100	JPA-1100	JCA-1100	JBR-1100	JAE-1100

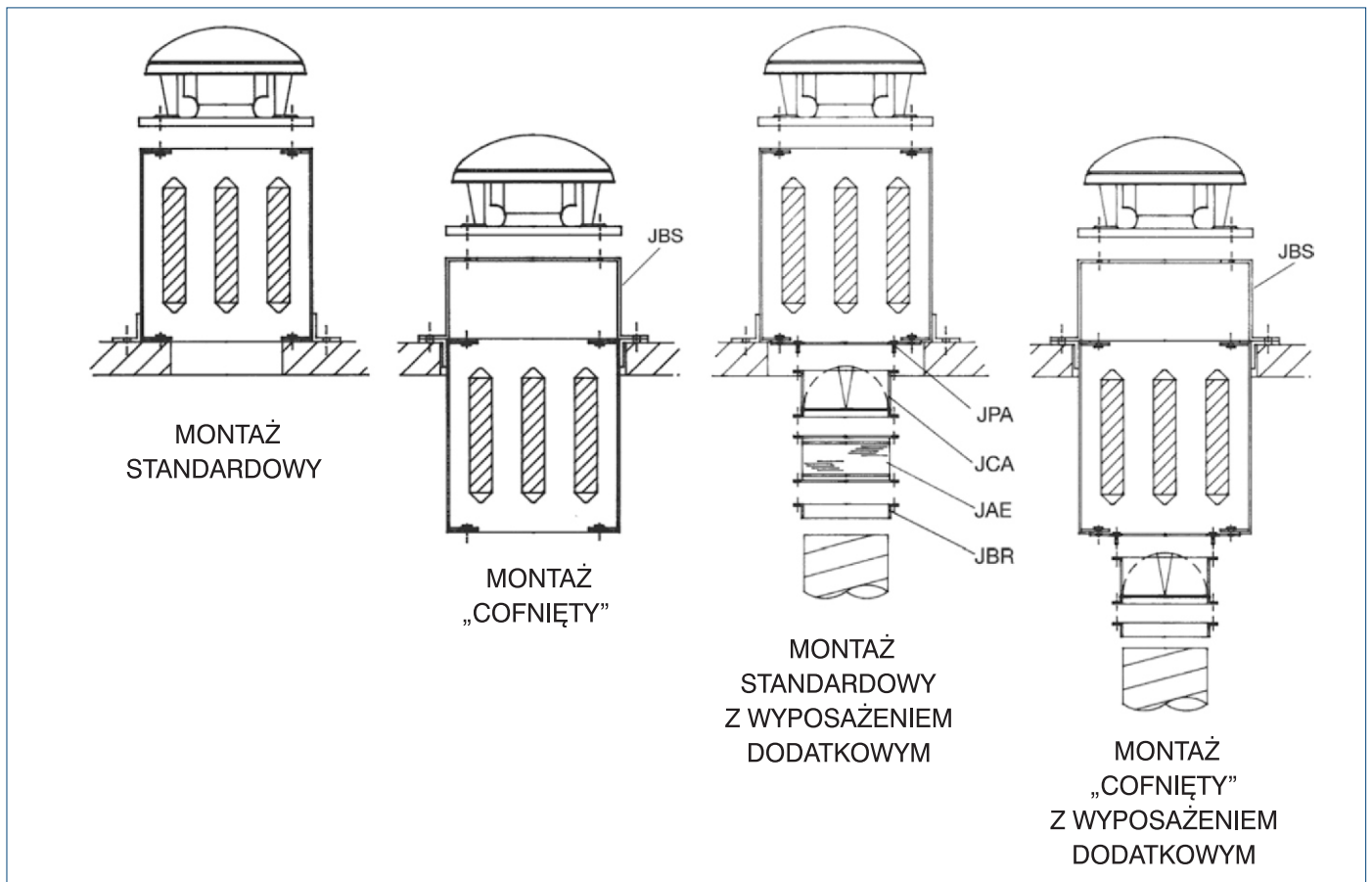
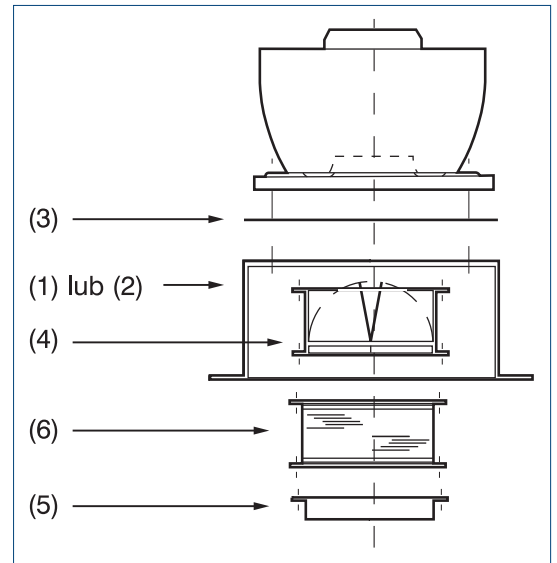

Tłumienie [dB]

Typ	125	250	500	1000	2000	4000	8000
RSA/JAA 300	1	5	13	22	23	16	12
RSA/JAA 435	1	7	16	23	25	18	13
RSA/JAA 560	2	8	16	29	32	26	17
RSA/JAA 630	2	8	14	24	27	19	13
RSA/JAA 710	2	8	14	24	28	16	11
RSA/JAA 905	2	7	14	26	30	19	12
RSA/JAA 1000	2	7	16	27	32	20	13

Straty ciśnienia

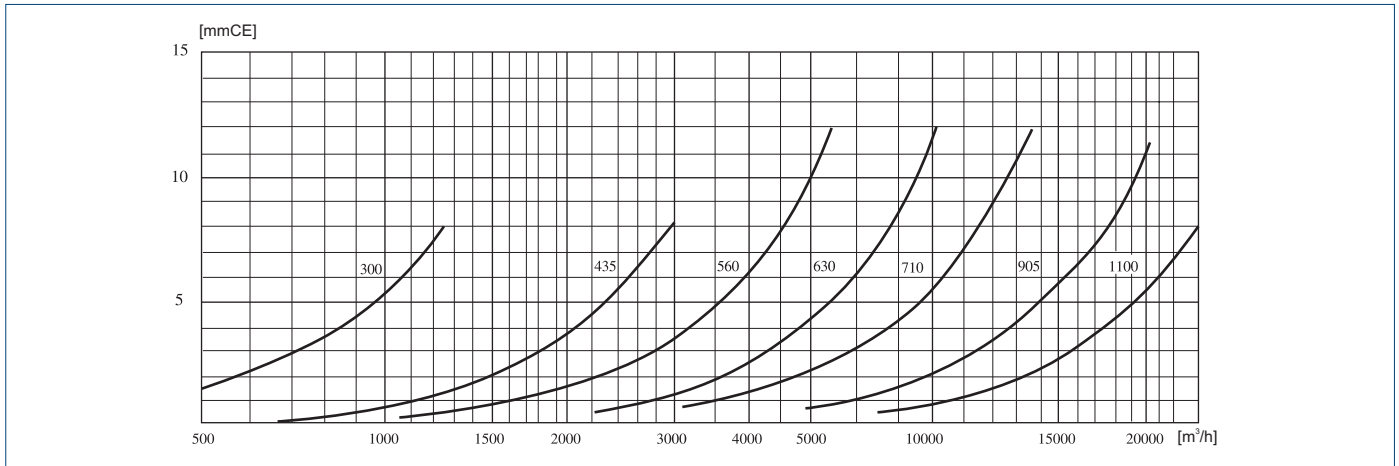

Charakterystyki pracy

Wartości dźwięku podane na wykresach są wielkościami ciśnienia akustycznego mierzonymi w odległości 1,5 m od wlotu wentylatora.

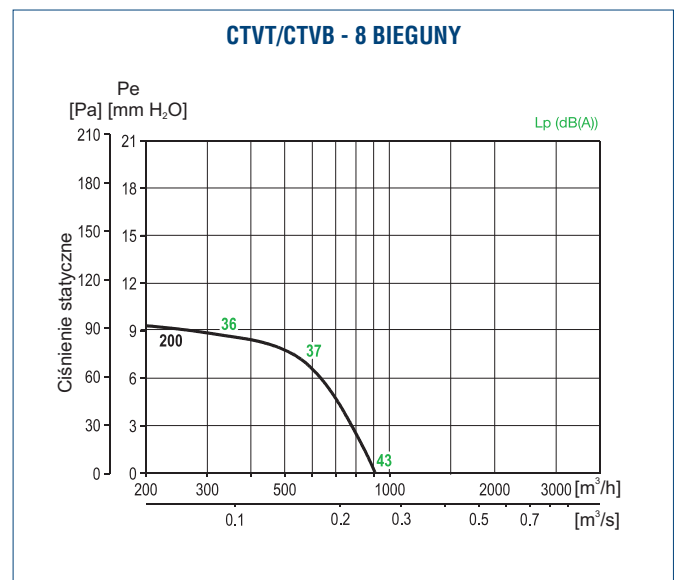
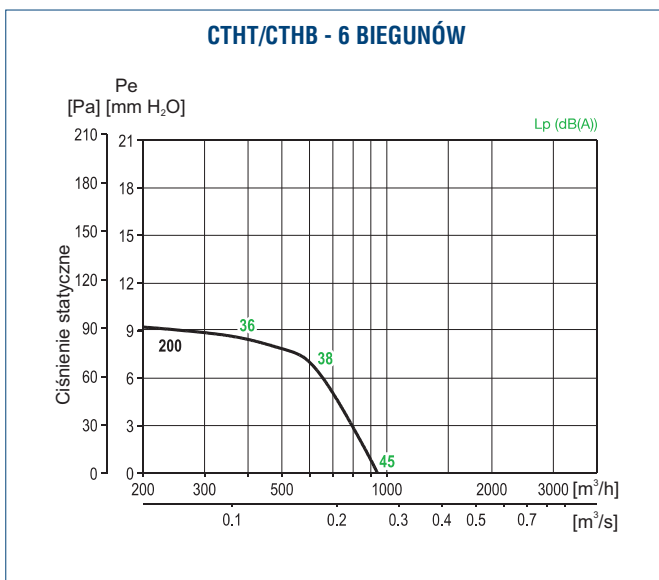
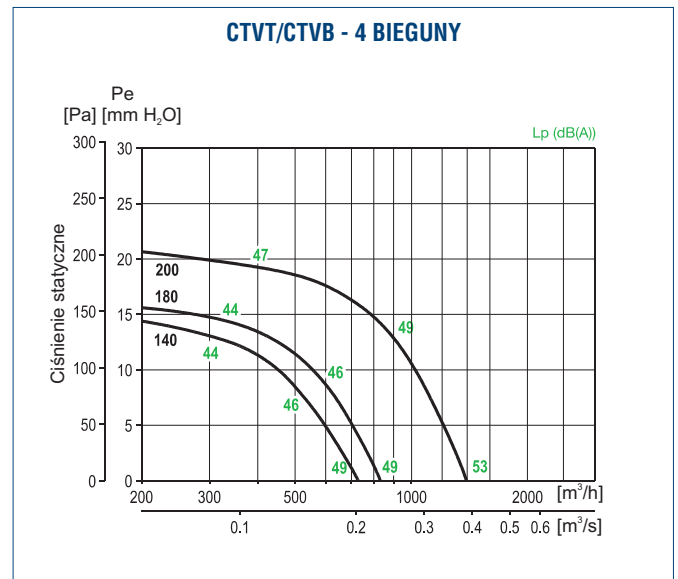
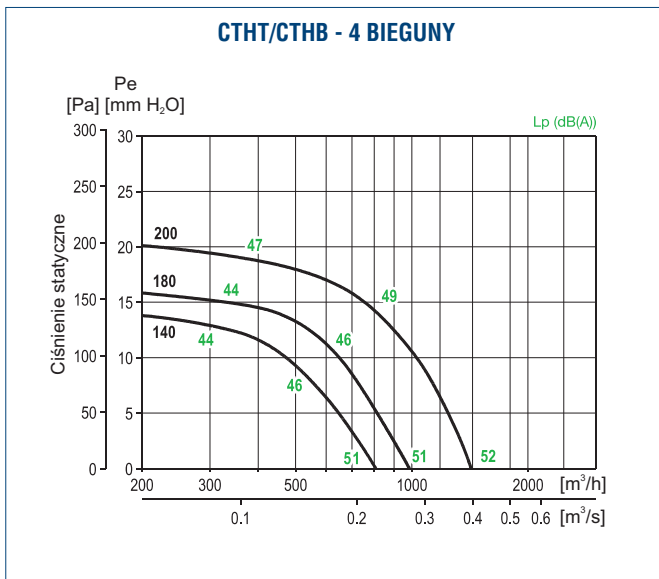

Charakterystyki pracy

Wartości dźwięku podane na wykresach są wielkościami ciśnienia akustycznego mierzonymi w odległości 1,5 m od wlotu wentylatora.

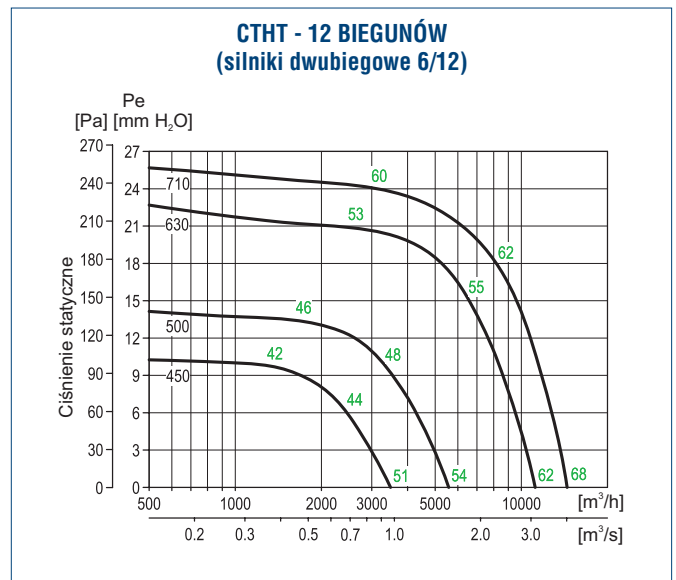
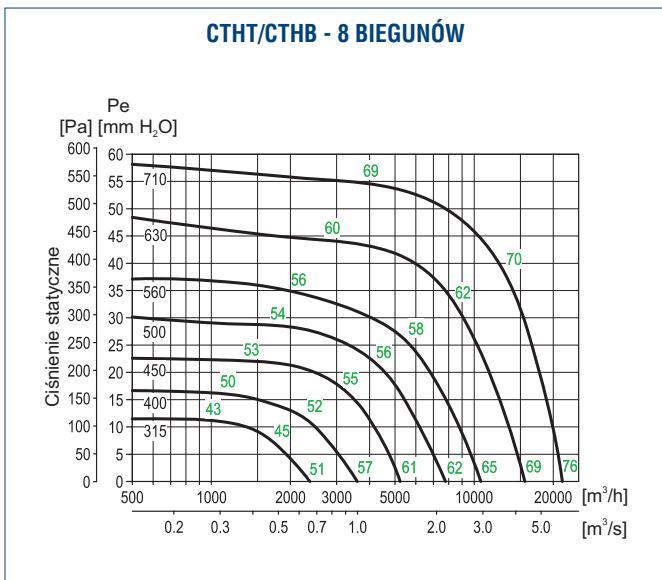
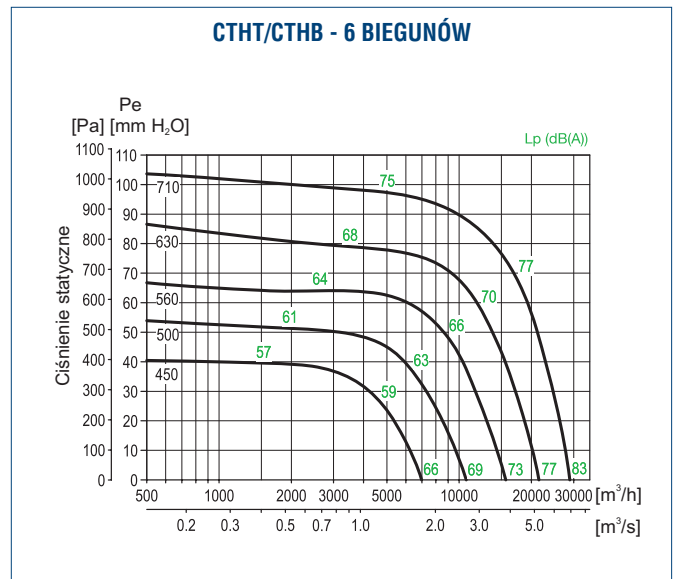
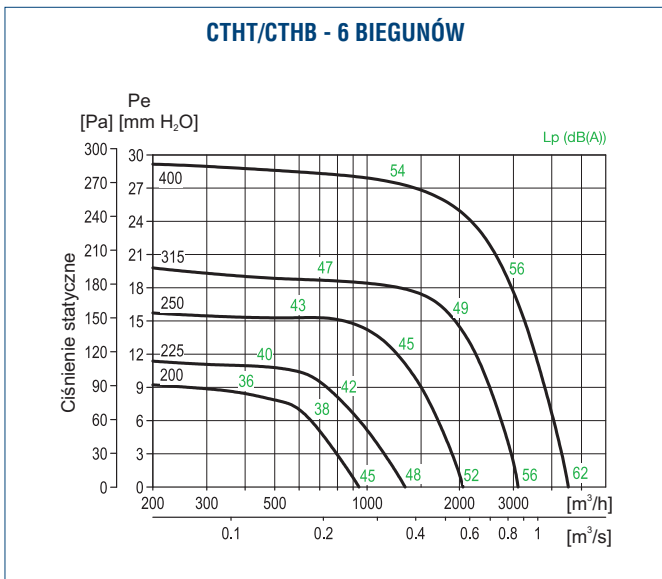
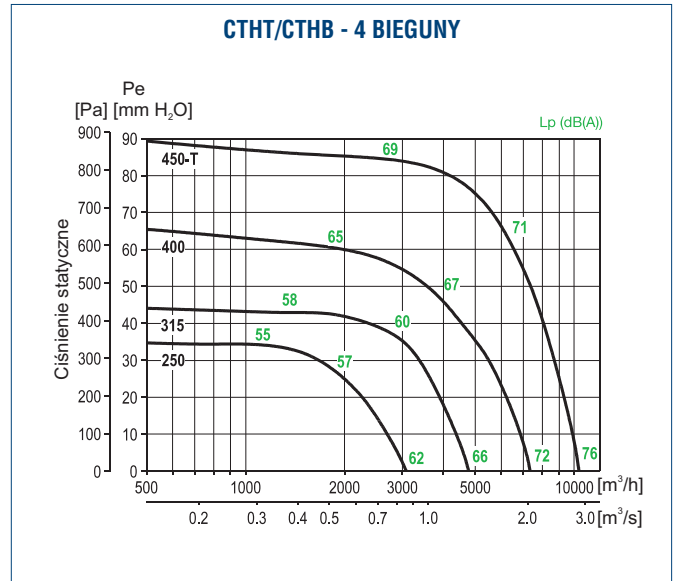
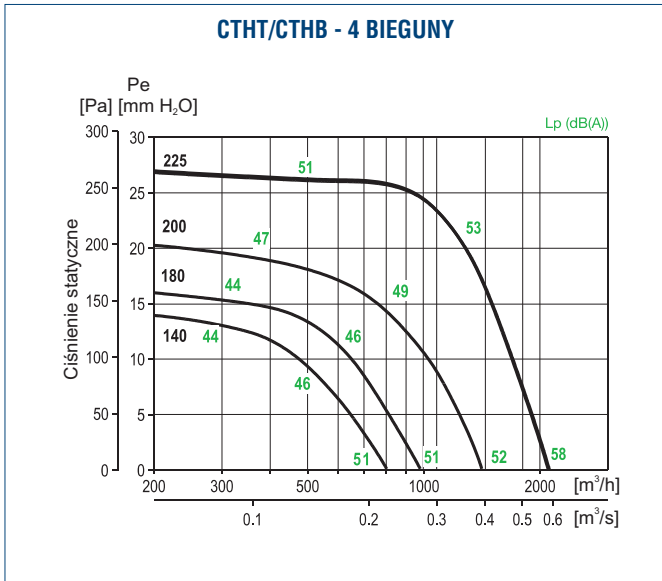

Charakterystyki pracy

Wartości dźwięku podane na wykresach są wielkościami ciśnienia akustycznego mierzonymi w odległości 1,5 m od wlotu wentylatora.

